

0-3

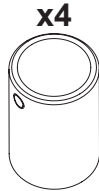

x1

x4



x4

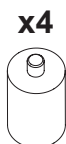

x4

x4



x2

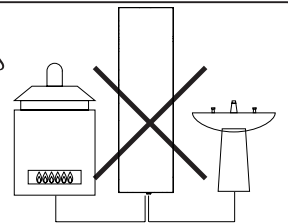

1

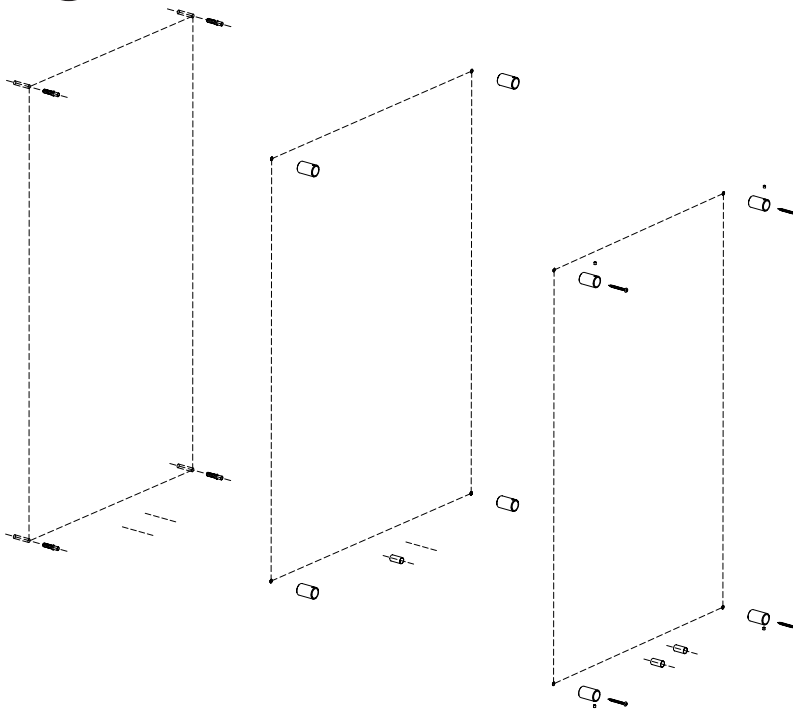

2

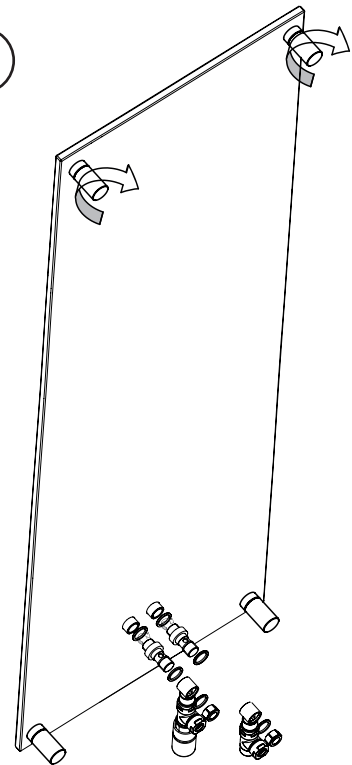

- I sistemi di fissaggio (viti + tasselli) sono idonei per impiego su pareti compatte o in laterizio forato. Per pareti in materiali diversi è responsabilità dell'installatore adottare sistemi di fissaggi appropriati.
- The fixing kits (screws + dowels) are suitable for compact wall or hollow bricks. For wall in different materials it is responsibility of the installer to use appropriate fixing.
- Les systèmes de fixation (vis + chevilles) sont aptes à être utilisés sur des parois compactes ou en briques creuses. Pour des parois avec des matériaux différents, la responsabilité sera de l'installateur qui devra utiliser des systèmes de fixation appropriés.
- Die Verbindungselemente (Schrauben + Dübel) sind für den Einsatz in kompakten oder hohlen Ziegelmauern. Bei Einsatz in unterschiedliche Materialien liegt in der Verantwortung des Installateurs geeignete Verbindungselemente einzusetzen.



3

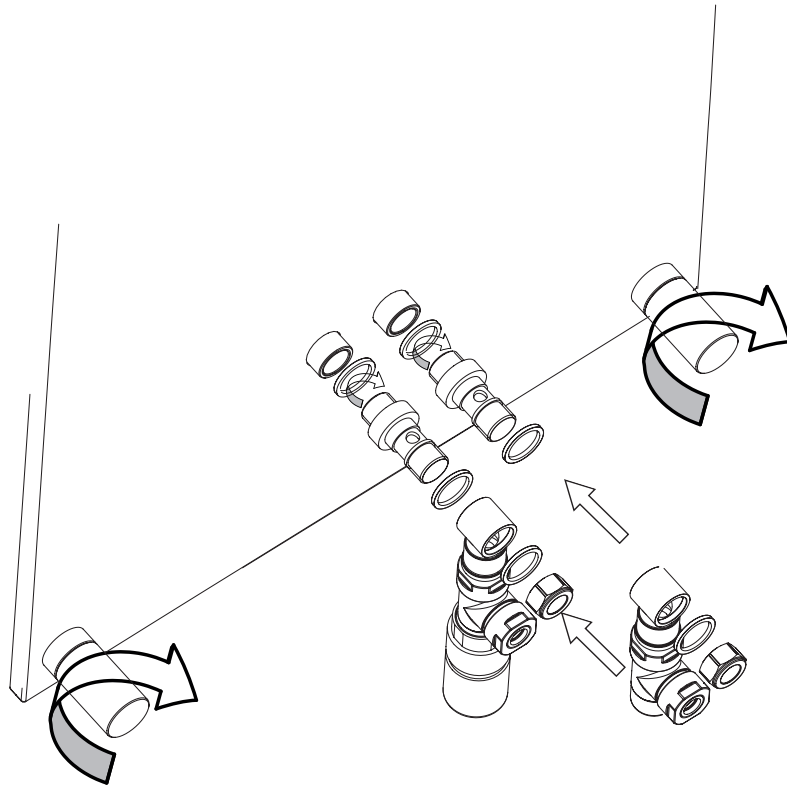
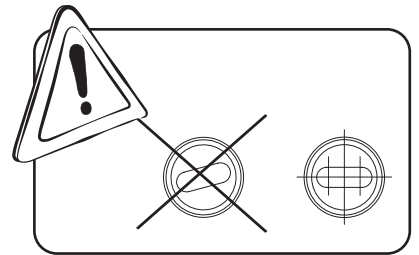

4

